

SONY[®]

4-193-041-12

LCD
Digital Colour TV

Operating Instructions

Start-up Guide

Instruction Manual

Additional Information

BRAVIA

KDL-19BX200 / KDL-22BX200

NOTICE FOR CUSTOMERS IN THE UNITED KINGDOM

A moulded plug complying with BS1363 is fitted to this equipment for your safety and convenience. Should the fuse in the plug supplied need to be replaced, a 5 AMP fuse approved by ASTA or BSI to BS 1362 (i.e., marked with or) must be used.

When an alternative type of plug is used it should be fitted with a 5 AMP FUSE otherwise the circuit should be protected by a 5 AMP FUSE at the distribution board. If the plug supplied with this equipment has a detachable fuse cover, be sure to attach the fuse cover after you change the fuse. Never use the plug without the fuse cover. If you should lose the fuse cover, please contact your nearest Sony service station.

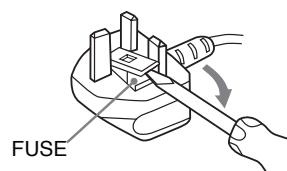
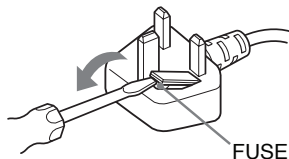

How to replace the fuse

Open the fuse compartment with a blade screwdriver, and replace the fuse. Please refer to the illustration that actually equipped with the product.

Introduction

Thank you for choosing this Sony product. Before operating the TV, please read this manual thoroughly and retain it for future reference.

Notice for Digital TV function

- Any functions related to Digital TV (**DVB**) will only work in countries or areas where DVB-T (MPEG2 and H.264/MPEG4 AVC) digital terrestrial signals are broadcasted.
- Although this TV set follows DVB-T specifications, compatibility with future DVB-T digital terrestrial broadcasts cannot be guaranteed.
- Some Digital TV functions may not be available in some countries / areas.

The manufacturer of this product is Sony Corporation, 1-7-1 Konan Minato-ku Tokyo, 108-0075 Japan. The Authorized Representative for EMC and product safety is Sony Deutschland GmbH, Hedelfinger Strasse 61, 70327 Stuttgart, Germany. For any service or guarantee matters please refer to the addresses given in separate service or guarantee documents.

Trademark information

DVB is a registered trademark of the DVB Project.

HDMI, the HDMI logo and High-Definition Multimedia Interface are trademarks or registered trademarks of HDMI Licensing LLC.

Manufactured under license from Dolby Laboratories. Dolby and the double-D symbol are trademarks of Dolby Laboratories.

"BRAVIA" and BRAVIA are trademarks of Sony Corporation.

HDMI[™]
HIGH-DEFINITION MULTIMEDIA INTERFACE

DOLBY
DIGITAL PLUS

Location of the identification label

Labels for Model No. and Power Supply rating (in accordance with applicable safety regulation) are located on the rear of the TV.

Table of Contents

Start-up Guide	4
Safety Information	7
Precautions	8
Overview of the remote	9
Overview of the TV buttons and indicators.....	11
Watching TV	
Watching TV	12
Using the Digital Electronic Programme Guide (EPG) DV3	14
Using the Digital Favourite List DV3	15
Using Optional Equipment	
Connecting optional equipment	16
Viewing pictures from connected equipment.....	18
Playing Back Photo/Music via USB.....	18
Using Control for HDMI.....	19
Using MENU functions	
Navigating through menus.....	20
TV Settings Menu	21
Additional Information	
Installing the Accessories (Wall-Mount Bracket).....	30
Specifications.....	31
Troubleshooting.....	33

Before operating the TV, Please read “Safety Information (page 7). Retain this manual for future reference.

DV3: for digital channels only.

Start-up Guide

1: Checking the accessories

Mains lead (1)

Remote RM-ED037 (1)

Table-top stand (1)

Size AA batteries (R6 type) (2)

To insert batteries into the remote

Push and lift the tab to open the cover.

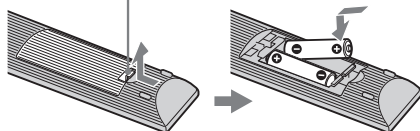

- Observe the correct polarity when inserting batteries.
- Do not use different types of batteries together or mix old and new batteries.
- Dispose of batteries in an environmentally friendly way. Certain regions may regulate disposal of batteries. Please consult your local authority.
- Handle the remote with care. Do not drop or step on it, or spill liquid of any kind onto it.
- Do not place the remote in a location near a heat source, a place subject to direct sunlight, or a damp room.

2: Attaching the stand

Follow these steps to attach the stand to the TV.

- 1 Open the carton box and take out the stand.
- 2 Place the TV set on the stand.

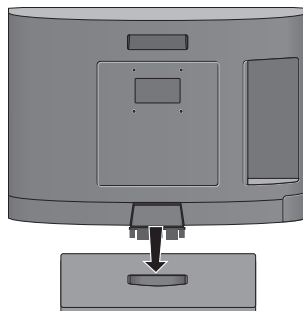

- 3 Seat the TV onto stand by pressing the top of the TV slightly.

3: Connecting an aerial/Satellite Receiver/DVD Recorder

Connecting an aerial

Coaxial cable

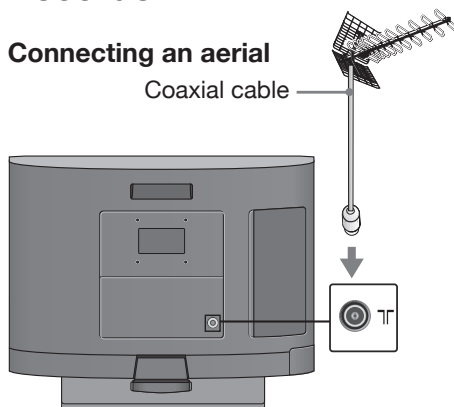

**Connecting a satellite receiver/
recorder (e.g. DVD recorder) with
SCART**

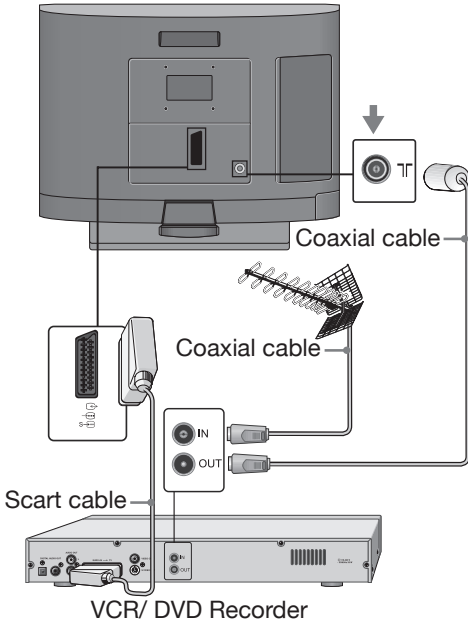

**Connecting a satellite receiver/
recorder (e.g. DVD recorder) with
HDMI**

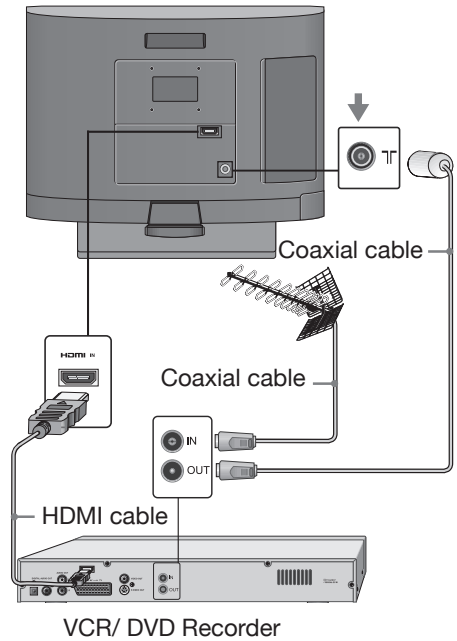

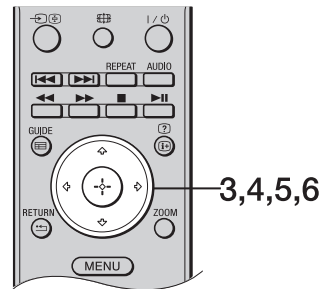
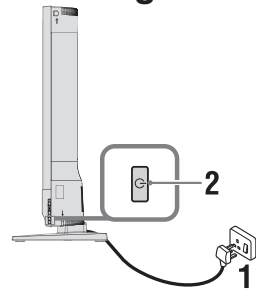

4: Initial settings



1 Connect the TV to your mains socket.





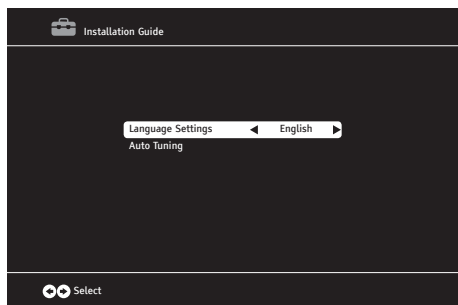

2 Press  on the TV.

When you turn on the TV for the first time, the "Installation Guide" menu appears on the screen.

3 Press / to select the language. Your language selection appears on the screen.



4 Press / to select "Auto Tuning", then press .

5 Press / to select the country. Press / to select "Scan Type". Then, press / to select ATV (Analogue TV) & DTV (Digital TV), DTV or ATV. "Time Zone" will change automatically according to the country selection. Press  to start auto tuning.

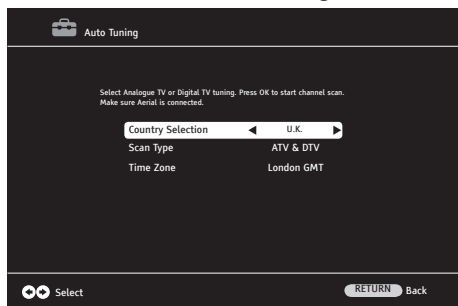

- Auto tuning can take a few minutes depending on the number of the available TV channels.
- You can also tune the channels manually (page 24).
- Tuning is completed when the programme table appears on the screen.

6 Press MENU to exit.

Detaching the Table-Top Stand from the TV



- Press the tabs (A) and pull the stand in the direction of arrow.
- Do not remove the stand for any reason other than to wall-mount the TV.

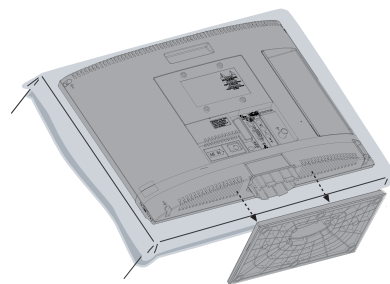
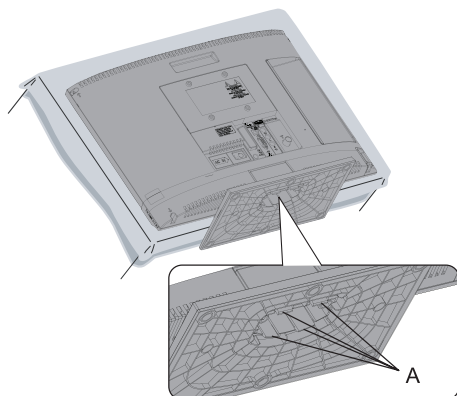

Safety Information

Installation/Set-up

Install and use the TV set in accordance with the instructions below in order to avoid any risk of fire, electrical shock or damage and/or injuries.

Installation

- The TV set should be installed near an easily accessible mains socket.
- Place the TV set on a stable, level surface.
- Only qualified service personnel should carry out wall installations.

6.5 mm - 10 mm

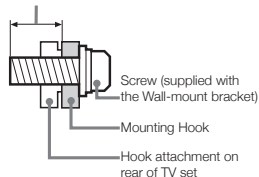

Transporting

- Before transporting the TV set, disconnect all cables.
- When transporting the TV set by hand, hold it as shown on the right. Do not put stress on the LCD panel.
- When transporting the TV set, do not subject it to jolts or excessive vibration.
- When transporting the TV set for repairs or when moving, pack it using the original carton and packing material.

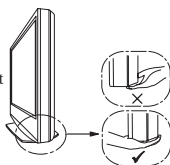

Ventilation

- Never cover the ventilation holes or insert anything in the cabinet.
- Leave space around the TV set as shown below.

Installed on the wall

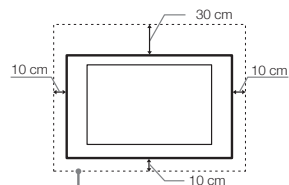

Leave at least this space around the set.

Installed with stand

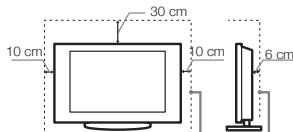

Leave at least this space around the set.

- To ensure proper ventilation and prevent the collection of dirt or dust:
 - Do not lay the TV set flat, install upside down, backwards, or sideways.
 - Do not place the TV set on a shelf, rug, bed or in a closet.
 - Do not cover the TV set with items such as curtains or newspapers, etc.
 - Do not install the TV set as shown below.

Air circulation is blocked.

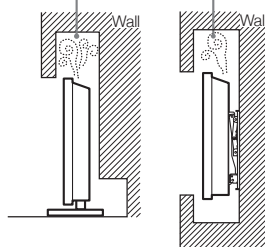

Mains lead

Handle the mains lead and socket as follows in order to avoid any risk of fire, electrical shock or damage and/or injuries:

- Use only mains leads supplied by Sony, not other suppliers.
- Insert the plug fully into the mains socket.
- Operate the TV set on a 220–240 V - 50-60 Hz supply only.
- When wiring cables, be sure to unplug the mains lead for your safety and take care not to catch your feet on the cables.
- Disconnect the mains lead from the mains socket before working on or moving the TV set.
- Keep the mains lead away from heat sources.
- Unplug the mains plug and clean it regularly. If the plug is covered with dust and it picks up moisture, its insulation may deteriorate, which could result in a fire.

Notes

- Do not use the supplied mains lead on any other equipment.
- Do not pinch, bend, or twist the mains lead excessively. The core conductors may be exposed or broken.
- Do not modify the mains lead.
- Do not put anything heavy on the mains lead.
- Do not pull on the mains lead itself when disconnecting the mains lead.

- Do not connect too many appliances to the same mains socket.
- Do not use a poor fitting mains socket.

Prohibited Usage

Do not install/use the TV set in locations, environments or situations such as those listed below; otherwise the TV set may malfunction and cause a fire, electrical shock, damage and/or injuries.

Location:

Outdoors (in direct sunlight), at the seashore, on a ship or other vessel, inside a vehicle, in medical institutions, unstable locations, near water, rain, moisture or smoke.

Environment:

- To prevent the spread of fire, keep candles or other open flames away from this product at all time.
- Places that are hot, humid, or excessively dusty; where insects may enter; where it might be exposed to mechanical vibration, near flammable objects (candles, etc). TV set shall not be exposed to dripping or splashing and no objects filled with liquids, such as vases, shall be placed on the TV.



Situation:

Do not use when your hands are wet, with the cabinet removed, or with attachments not recommended by the manufacturer. Disconnect the TV set from mains socket and aerial during lightning storms.

Broken pieces:

- Do not throw anything at the TV set. The screen glass may break by the impact and cause serious injury.
- If the surface of the TV set cracks, do not touch it until you have unplugged the mains lead. Otherwise electric shock may result.

When not in use

- If you will not be using the TV set for several days, the TV set should be disconnected from the mains for environmental and safety reasons.
- As the TV set is not disconnected from the mains when the TV set is just turned off, pull the plug from the mains to disconnect the TV set completely.
- However, some TV sets may have features that require the TV set to be left in standby to work correctly.

For children

- Do not allow children to climb on the TV set.
- Keep small accessories out of the reach of children, so that they are not mistakenly swallowed.

If the following problems occur...

Turn off the TV set and unplug the mains lead immediately if any of the following problems occur.

Ask your dealer or Sony service centre to have it checked by qualified service personnel.

When:

- Mains lead is damaged.
- Poor fitting of mains socket.
- TV set is damaged by being dropped, hit or having something thrown at it.
- Any liquid or solid object falls through openings in the cabinet.

Precautions

Viewing the TV

- View the TV in moderate light, as viewing the TV in poor light or for a long period of time strains your eyes.
- When using headphones, adjust the volume so as to avoid excessive levels, as hearing damage may result.

LCD Screen

- Although the LCD screen is made with high-precision technology and 99.99% or more of the pixels are active, black dots or bright points of light (red, blue, or green) may appear constantly on the LCD screen. This is a structural feature of the LCD screen and is not a malfunction.
- Do not push or scratch the front filter, or place objects on top of this TV set. The image may be uneven or the LCD screen may be damaged.
- If this TV set is used in a cold place, a smear may occur in the picture or the picture may become dark. This does not indicate a failure. These phenomena disappear as the temperature rises.
- Ghosting may occur when still pictures are displayed continuously.
- The screen and cabinet get warm when this TV set is in use. This is not a malfunction.
- The LCD screen contains a small amount of liquid crystal. Some fluorescent tubes used in this TV set also contain mercury. Follow your local ordinances and regulations for disposal.

Handling and cleaning the screen surface/cabinet of the TV set

Be sure to unplug the mains lead connected to the TV set from mains socket before cleaning.

To avoid material degradation or screen coating degradation, observe the following precautions.

- To remove dust from the screen surface/cabinet, wipe gently with a soft cloth. If dust is persistent, wipe with a soft cloth slightly moistened with a diluted mild detergent solution.

- Do not spray water or detergent directly on the TV set. It may drip to the bottom of the screen or exterior panels, and may cause a malfunction.
- Never use any type of abrasive pad, alkaline/acid cleaner, scouring powder, or volatile solvent, such as alcohol, benzene, thinner or insecticide. Using such materials or maintaining prolonged contact with rubber or vinyl materials may result in damage to the screen surface and cabinet material.
- Periodic vacuuming of the ventilation openings is recommended to ensure to proper ventilation.
- When adjusting the angle of the TV set, move it slowly so as to prevent the TV set from moving or slipping off from its table stand.

Optional Equipment

- Keep optional components or any equipment emitting electromagnetic radiation away from the TV set. Otherwise picture distortion and/or noisy sound may occur.
- This product has been tested and found to be compliant with the limits set out in the EMC Directive for using connection cables not longer than 3 meters.

Batteries

- Observe the correct polarity when inserting batteries.
- Do not use different types of batteries together or mix old and new batteries.
- Dispose of batteries in an environmentally friendly way. Certain regions may regulate disposal of batteries. Please consult your local authority.
- Handle the remote with care. Do not drop or step on it, or spill liquid of any kind onto it.
- Do not place the remote in a location near a heat source, a place subject to direct sunlight, or a damp room.

Disposal of the TV set Disposal of Old Electrical & Electronic Equipment (Applicable in the European Union and other European countries with separate collection systems)



This symbol on the product or on its packaging indicates that this product shall not be treated as household waste. Instead it shall be handed over to the applicable collection

point for the recycling of electrical and electronic equipment. By ensuring this product is disposed of correctly, you will help prevent potential negative consequences for the environment and human health, which could otherwise be caused by inappropriate waste handling of this product. The recycling of materials will help to conserve natural resources. For more detailed information

about recycling of this product, please contact your local Civic Office, your household waste disposal service or the shop where you purchased the product.

Disposal of waste batteries (applicable in the European Union and other European countries with separate collection systems)



This symbol on the battery or on the packaging indicates that the battery provided with this product shall not be treated as household waste. On certain batteries this symbol might be used in combination with a chemical symbol. The chemical symbols for mercury (Hg) or lead (Pb) are added if the battery contains more than 0.0005% mercury or 0.004% lead. By ensuring these batteries are disposed of correctly, you will help prevent potential negative consequences for the environment and human health, which could otherwise be caused by inappropriate waste handling of this product. The recycling of materials will help to conserve natural resources. In case of products that for safety, performance or data integrity reasons require a permanent connection with an incorporated battery, this battery should be replaced by qualified service staff only. To ensure that the battery will be treated properly, hand over the product at end-of-life to the applicable collection point for the recycling of electrical and electronic equipment. For all other batteries, please view the section on how to remove the battery from the product safely. Hand the battery over to the applicable collection point for the recycling of waste batteries. For more detailed information about recycling of this product or battery, please contact your local Civic Office, your household waste disposal service or the shop where you purchased the product.

Overview of the remote

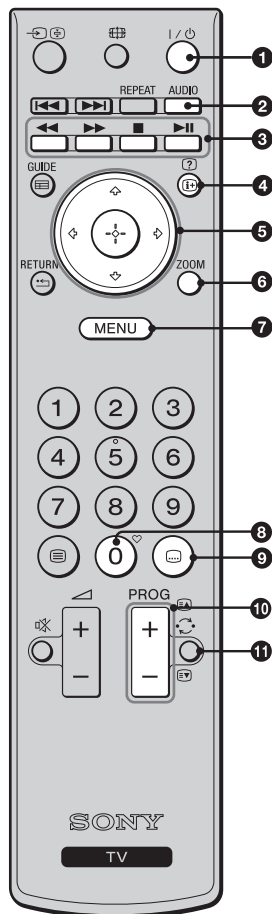

- 1 I/⏻ - TV standby**
Turns the TV on and off from standby mode.
- 2 AUDIO**
In Analogue Mode: Changes the dual sound mode (page 23).
In Digital Mode: Changes the audio language for the current programme you are watching (page 27)
- 3 Coloured buttons (page 13)**
- 4 (i+)/(?) - Info / Text reveal**
In Digital Mode: Displays brief details of the programme currently being watched, and the information of the next programme
In Analogue Mode: Displays current channel number and date information.
In Teletext Mode: Reveals hidden information (e.g. answers to a question) (page 13)
- 5 ⬆/⬇/⬅/➡/⬆/⬇/⬅/➡/⬆/⬇/⬅/➡/⬆/⬇/⬅/➡/⬆/⬇/⬅/➡**
- 6 ZOOM**
In TV Mode: Enlarges the picture in 3 steps by focusing on the center.
In Teletext Mode: Enlarges the teletext page in 2 steps.
- 7 MENU (page 20)**
- 8 ♥ - Favourite list**
Displays the favourite list that you have specified (page 15)
- 9 ... (Subtitle)**
Changes the subtitle language (page 27) (only in digital mode)
- 10 PROG +/-/(EΔ)/(E▽)**
In TV Mode: Selects the next (+) or previous (-) channel.
In Teletext Mode (page 13): Selects the next (EΔ) or previous (E▽) page.
- 11 ↻ - (Previous channel)**
Returns to the previous channel watched.

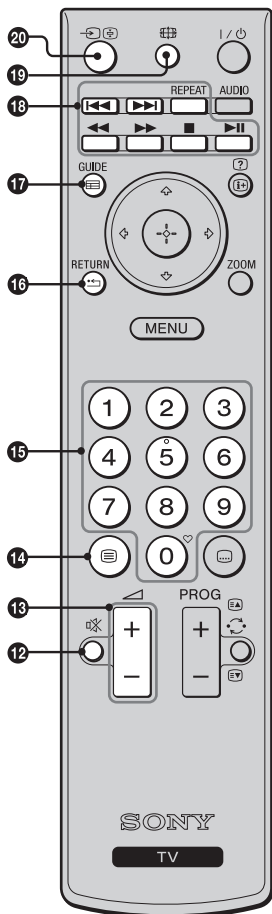

- 12** **Mute**
Turns on or off the sound temporarily.
- 13** **Volume**
Increases (+) or decreases (-) the volume.
- 14** **Teletext (page 13)**
Press to display teletext information.
- 15** **Number buttons**
In TV Mode: Selects channels. For channel numbers 10 and above, press the second and third digits in quick succession.
In Teletext Mode: Enters the page numbers to select the page.
- 16** **RETURN**
Returns to the previous screen of any displayed menu.
- 17** **GUIDE/A/B**
In Digital Mode: EPG (Digital Electronic Programme Guide) (page 14)
- 18** **Buttons for optional equipment.**
Operates the equipment connected to the TV. (page 18)
- 19** **Picture format**
Selects the picture format (page 13).
- 20** **Input select/Text hold**
In TV Mode: Displays the source list (page 18).
In Teletext Mode: Stop the selected teletext page.



- The number 5, PROG + and AUDIO buttons have tactile dots. Use the tactile dots as references when operating the TV.

Overview of the TV buttons and indicators

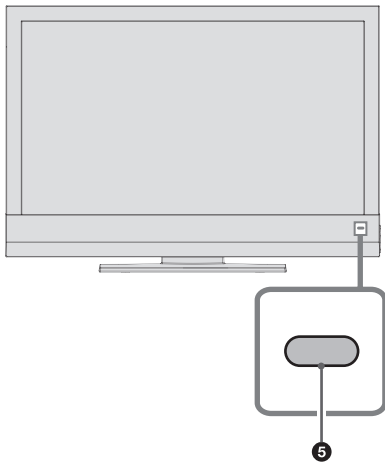
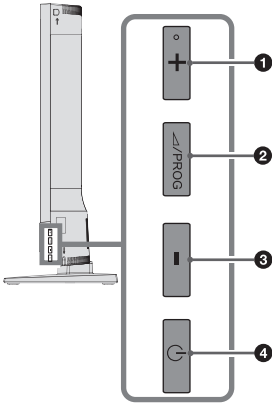

- 1** ◀ + / **PROG +**
Increases the volume / selects the next channel.
- 2** ◀ / **PROG**
Switches between volume / channel selection options.
- 3** ▶ - / **PROG -**
Decreases the volume / selects the previous channel.
- 4** ⏻ - **Power**
Turns on / off the TV.
To disconnect the TV completely, pull the plug from the mains.
- 5** **Power/Standby Indicator and Remote control sensor**
 - Lights up in green when the TV is turned on.
 - Lights up in red when the TV is in standby mode.
 - Receives IR signals from the remote. Do not put anything over the sensor, as its function may be affected.



- Make sure that the TV is completely turned off before unplugging the mains lead. Unplugging the mains lead while the TV is turned on may cause the TV to malfunction.

Watching TV

Watching TV

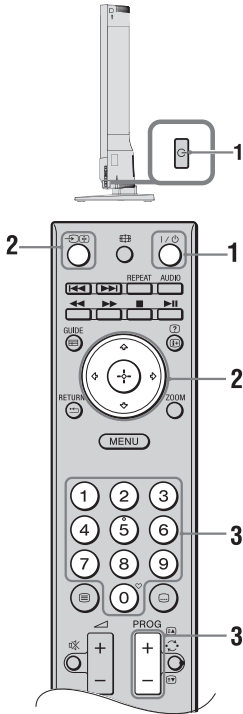

1 Press on the TV or on the remote to turn on the TV. Standby indicator on the front panel of the TV changes to green from red.

2 Press to switch to digital or analogue mode. Input source menu appears on the display.

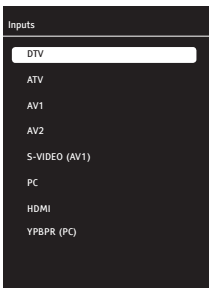

Press / to select DTV for digital mode or ATV for analogue mode, then confirm with . Your TV will switch to the selected mode.

3 Press the number buttons or PROG +/- to select a TV channel.

- For channel numbers 10 and above, press the second and third digits in quick succession.
- To select a digital channel using the Digital Electronic Programme Guide (EPG), see page 14.

In digital mode

An information banner appears briefly. The following icons may be indicated on the banner.

- Interactive service is available (MHEG Digital Text)
- Radio service
- Scrambled/Subscription service
- Multiple audio languages available
- Subtitles available
- Subtitles available for the hearing impaired
- Recommended minimum age for current programme (from 4 to 18 years)
- Parental Lock

Additional operations

To	Do this
Adjust the volume	Press (increase)/- (decrease) button.
Select a channel from the channel list	Press . Press / to select the desired channel from the channel list, then press .
Select the favourite lists	Press . For details, see page 15.

To access Teletext

In analogue mode, press . Each time you press , the display changes cyclically as follows: Picture and Teletext → Teletext → No Teletext (Exit the Teletext service).

- Press number buttons or / to select a page.
- Press / to hold a page.
- Press / to reveal hidden information on a page.
- If there are subpages under a page and if you do not want to wait for auto scrolling, press button for previous pages and button for following pages.
- Press ZOOM twice to enlarge the text on a page in two steps; first press will enlarge the upper half and second press will enlarge the lower half of the page.



- When four coloured items appear at the bottom of the Text page, Fastext is available. Fastext allows you to access pages quickly and easily. Press the corresponding coloured button to access the page.

To change the screen format manually

Press repeatedly to select the desired screen format.

Wide

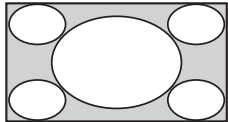

Displays wide screen broadcasts (16:9) in the correct proportions.

14:9*

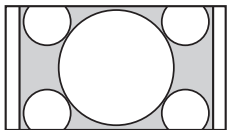

Displays 14:9 broadcasts in the correct proportions. As a result, black border areas are visible on the screen.

4:3

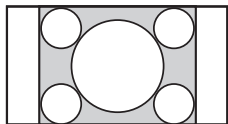

Displays conventional 4:3 broadcasts (e.g. nonwide screen TV) in the correct proportions.

LetterBox*

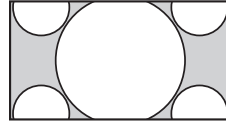

Displays cinematic broadcasts in the correct proportions.

Subtitle*

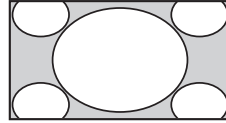

Displays cinematic broadcasts with subtitles on the screen.

Panorama*

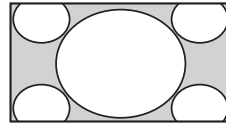

Displays conventional 4:3 broadcasts with an imitation wide screen effect. The 4:3 picture is stretched to fill the screen.

Auto

Automatically changes the screen format to suit the broadcast signal.

Overscan: Off

When this mode is selected, high defined picture is not cropped and it is displayed in its original size.

*Top and bottom parts of the picture may be cut off.



- Depending on the signal, some screen formats may not be selectable.
- Some characters and/or letters at the top and the bottom of the picture may not be visible in "Panorama".

Using the Digital Electronic Programme Guide (EPG) DVB

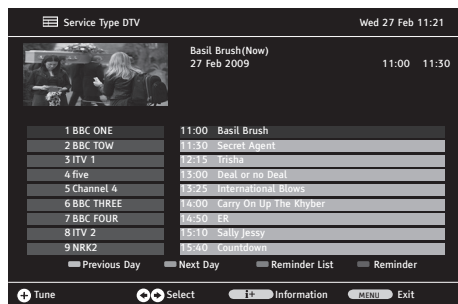

- 1 In digital mode, press GUIDE.
- 2 Perform the desired operation as shown in the following table or displayed on the screen.

* This function may not be available in some countries/regions.

To	Do this
Watch a programme	Press to select a programme, then press .
Turn off the EPG	Press GUIDE.
Display the current programme information, and the information for the previous or next day's programme	<ol style="list-style-type: none"> 1 Press to select the channel whose programme information you want to display, then press . Programme information line will be activated. 2 Press red button to display the previous day's information and press green button to display the next day's information. 3 Press to select the programme information titles, then press for details.
To set a reminder for a programme	<ol style="list-style-type: none"> 1 Press to select the channel for which a reminder will be set, then press . Programme information line will be activated. 2 Press to select the programme information title for which a reminder will be set, then press blue button. 3 Enter the reminder information and press . 4 Press RETURN to finish setting up.
Cancel a set reminder	<ol style="list-style-type: none"> 1 In EPG menu, press yellow button. 2 Press to select the reminder to be cancelled. 3 Press red button to delete the reminder. 4 Press RETURN to finish setting up.

Using the Digital Favourite List DV3

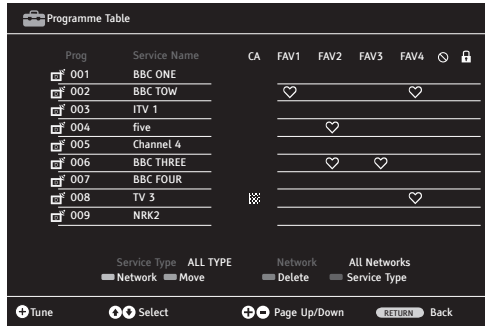

* This function may not be available in some countries/regions.

You can create four different favourite channel lists.

- 1 Perform the following operations to open the programme table.
MENU → ⏴ → Settings → ⊕ → ⏴ → Channel Setup → ⊕ → ⏴ → Programme Table → ⊕.
- 2 Perform the desired operation as shown in the following table or displayed on the screen.

To	Do this
Add or remove channels from a favourite list	<ol style="list-style-type: none"> 1 Press ⏴/⏵ to select the channel you want to add to the favourite list. 2 Press ⏴/⏵ to select the favorite list to which the selected channel will be added, then press ⊕ . 3 ♥ symbol appears under the relevant favorite list for the channel added. 4 To remove a channel from the favorite list, select the relevant channel from the favorite list and press ⊕ . ♥ symbol will disappear. 5 Press RETURN ↵ to finish setting up.
Select a favourite list	<ol style="list-style-type: none"> 1 Press ♥ to select a favorite list. 2 In Favourite List menu, press ⏴/⏵ to select one of the lists from FAV1 to FAV4, then press ⊕ .
Watch a channel	<ol style="list-style-type: none"> 1 Open the desired favourite list. 2 Press ⏴/⏵ to select a channel, then press ⊕ .
Turn off the Favourite List	Press RETURN ↵.







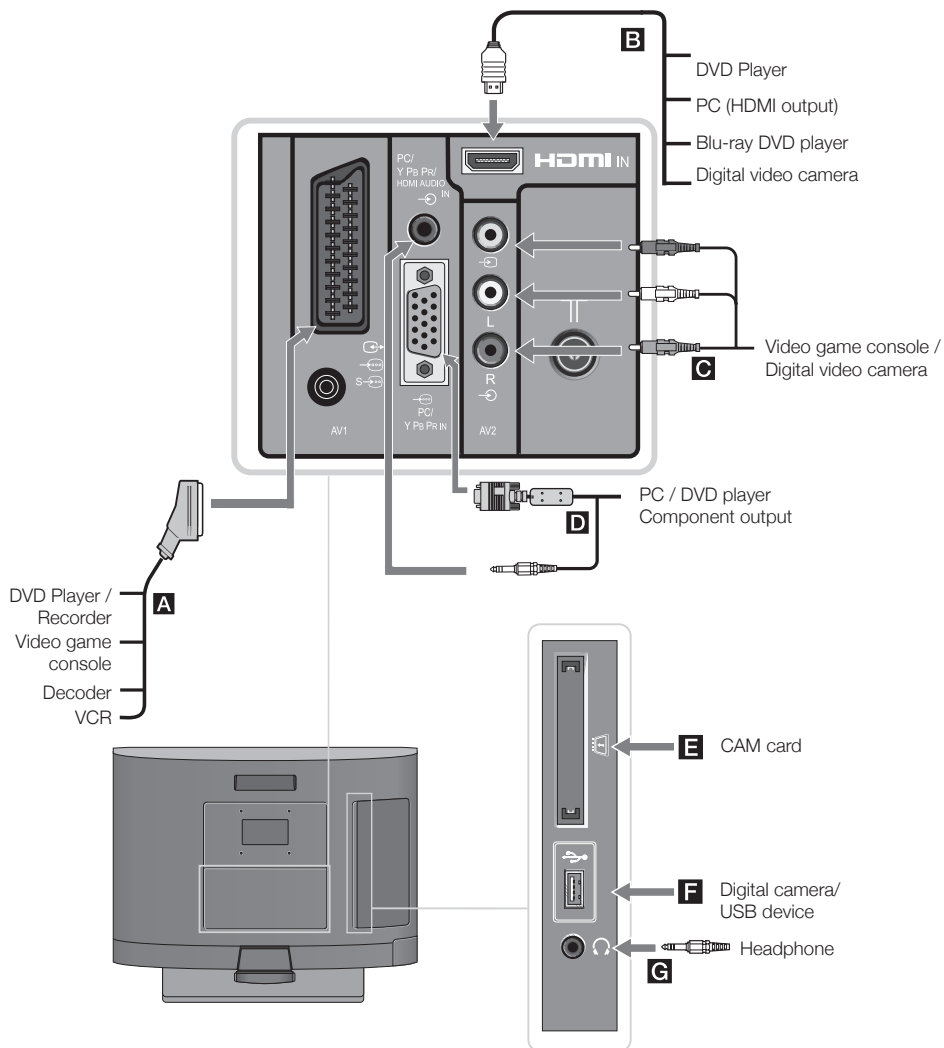



Using Optional Equipment

Connecting optional equipment

You can connect a wide range of optional equipment to your TV. Connection cables are not supplied.





Connecting audio-video equipment (quality order, high to low)

Connection point	Connect with	Description
B HDMI / 	HDMI Cable	<p>This is the input for digital video and audio signals. If the equipment has a DVI socket, connect the DVI socket to the HDMI socket through a DVI-HDMI adaptor interface (not supplied), and connect the equipment's audio out sockets to the PC/Y Pb Pr/HDMI Audio IN socket.</p> <p></p> <ul style="list-style-type: none"> HDMI input only supports the following video inputs: 480i, 480p, 576i, 576p, 720p, 1080i, 1080p, 1080/24p Use only a genuine HDMI cable bearing the HDMI logo. We recommend that you use a Sony HDMI cable (high-speed type).
D  PC / Y Pb Pr IN / 	VGA - Y Pb Pr cable, audio cable PC cable with ferrites, audio cable	<p>Connect your equipment through a VGA-Y Pb Pr adapter cable (not supplied) and connect the equipment's audio out sockets to PC/Y Pb Pr/HDMI Audio IN socket.</p> <p>It is recommended to use a PC cable with ferrites, such as the "Connector, D-sub 15" (ref. 1-793-504-11, available in Sony Service Center), or an equivalent.</p> <p></p> <ul style="list-style-type: none"> Y Pb Pr input only supports the following video inputs: 480i, 480p, 576i, 576p, 720p, 1080i, 1080p.
A  /  /  S-VIDEO / AV1	SCART cable	<p>You can connect a decoder. When you connect a decoder, scrambled broadcast signals are transmitted to the decoder where they are decoded and send to the television.</p> <p></p> <ul style="list-style-type: none"> You can connect a recorder (e.g. DVD recorder) directly to the TV.
C  AV2 / 	Composite video cable	

Connecting portable equipment



Connection point	Connect with	Description
F  USB	USB cable	You can enjoy photo/music files stored in a Sony digital still camera or camcorder through a USB cable or USB storage media on your TV (page 18).

Connecting other equipment

Connection point	Connect with	Description
E  CAM (Conditional Access Module)	CAM Module	<p>Allows access to Pay Per View TV services. For details, refer to the instruction manual supplied with your CAM module. To use the CAM module, turn off the TV and insert your CAM module into the slot.</p> <p></p> <ul style="list-style-type: none"> CAM is not supported in some countries/regions. Check with your authorised dealer.
G 	Headphone	You can listen to your TV with headphones.

Viewing pictures from connected equipment

Turn on the connected equipment, then perform the following operations.

- 1 Press  to display the "Input" source menu.
- 2 Press  to select the input source where your equipment is connected, then press  to confirm.

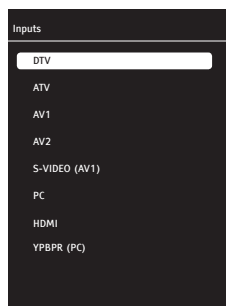

A AV1	Switches to the equipment connected to AV1 input.
A S-VIDEO (AV1)	Switches to the equipment connected to via AV1 input.
B HDMI	Switches to the equipment connected to HDMI input.
C AV2	Switches to the equipment connected to AV2 input.
D YPBPR (PC)	Switches to the equipment connected to component input PC.
D PC	Switches to the PC connected to PC input.

For equipment connected to scart socket through a all connected 21-pin scart cable







Start playing on the connected equipment. Picture from the connected equipment appears on the screen.

For a VCR connected automatically

In analogue mode, press **PROG +/-** or number buttons to select the video channel.

Playing Back Photo/Music via USB

You can enjoy photo/music files stored in a Sony digital still camera or camcorder through a USB cable or USB storage media on your TV.

- 1 Connect a supported USB device to the USB socket of the TV.
- 2 Press MENU.
- 3 Press  to select Photo or Music, then press  to confirm. File or folder list appears on the screen.
- 4 Press  to select a file or folder, then press  to confirm. Press red button to select all files. Press green button to deselect all selected files. When you select a folder, select a file, press  to highlight the file, then press  (blue) button. Playback starts. If you want to playback multiple photo or music files in the folder, press  to highlight them.





- While the TV is accessing the data on the USB device, observe the following:
 - Do not turn off the TV or connected USB device.
 - Do not disconnect the USB cable.
 - Do not remove the USB device.The data on the USB device may be damaged.
- Sony will not be held liable for any damage to, or loss of, data on the recording media due to a malfunction of any connected devices or the TV.
- USB playback is supported for the following photo file formats:
 - JPEG (DCF or Exif compatible JPEG files with the extension ".jpg").
- USB playback is supported for the following music file formats:
 - MP3 (files with the extension ".mp3" that have not been copyrighted).
- Only English is supported in file name and folder name.
- When you connect a Sony digital still camera, set the camera's USB connection mode to "Auto" or "Mass Storage." For more information about USB connection mode, refer to the instructions supplied with your digital still camera.
- Check the website below for updated information about compatible USB devices.
<http://support.sony-europe.com/TV/compatibility/>

To view a photo

- Slideshow

You can create a slideshow by selecting multiple photos. Each photo remains on the screen for the time you specified and then the next photo is displayed.

- 1** Selecting a photo.
You can select the photos from the connected USB equipment or from a predefined picture folder. For details on selecting photos, see page 18.
- 2** While selected photo is being displayed press MENU, then press \uparrow/\downarrow to select  (Settings) and press \oplus to confirm.
- 3** Press \uparrow/\downarrow to select , then press \oplus to confirm.
- 4** Press \uparrow/\downarrow to select Slide Show Interval, then press \leftarrow/\rightarrow to set it as 3s, 5s or 10s. Each photo remains on the screen for the time you specified here and then the next photo is displayed.
- 5** Press MENU repeatedly to exit the menu.

- Zooming in/out the photo

This function allows you to zoom in or out the photos.

- 1** Press ZOOM while the current photo is paused or played.



- Press ZOOM repeatedly. The photo will be zoomed in first and then zoomed out.

- Rotating a photo

This function allows you to rotate the photos for 90°.

- 1** Press \leftarrow/\rightarrow to rotate a photo for 90° while it is being played.

Using Control for HDMI

Control for HDMI function allows the equipment to control each other through the HDMI CEC (Consumer Electronics Control) feature defined by HDMI.

You can connect together the Sony HDMI compatible devices such as a TV and a DVD recorder with hard disk and audio system through HDMI cables to allow them control each other. Make sure that the compatible equipment is connected properly in order to use the Control for HDMI function.

To connect the equipment compatible with Control for HDMI

Connect the compatible equipment and the TV through an HDMI cable. For details, see page 17.

To make the Control for HDMI settings

Control for HDMI must be enabled both on the TV and on the connected equipment. See HDMI Settings (page 28) for settings on the TV. See instruction manual for the detailed settings of the connected equipment.

Control for HDMI functions

- Turns off the connected equipment together with the TV.
- Automatically activates the equipment input when the equipment is turned on.

Using MENU functions

Navigating through menus

MENU allows you to access and enjoy various convenient features of this TV. You can easily select channels and change the settings for your TV.

3 Follow the instructions on the screen.

4 Press MENU to exit.



- The options you can adjust vary depending on the situation.

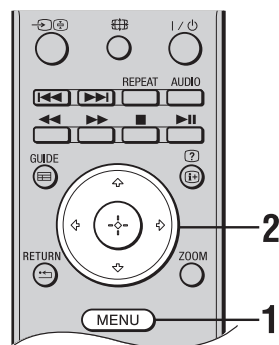

1 Press MENU to display the menu.

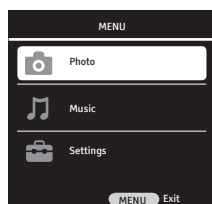

2 Press \uparrow/\downarrow to select an option, then press \oplus .

Symbol for the option	Description
Photo	You can access the photo files stored in USB equipment (page 18).
Music	You can access the music files stored in USB equipment (page 18).
Settings	You can adjust advanced settings (page 21).

TV Settings Menu

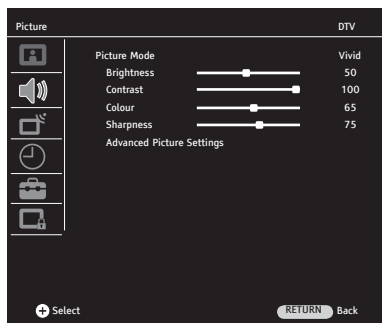

Perform the following operations to open the TV Settings menu.

- 1 Press MENU.
- 2 Press \uparrow/\downarrow to select  (Settings), then press \oplus to confirm.
- 3 Press \uparrow/\downarrow to select menu options, then press \oplus to confirm. Press MENU to exit.

Picture

Picture Mode	Selects the picture mode.	
	Vivid	Enhances picture contrast and sharpness.
	Natural	Provides optimum picture quality by increasing picture contrast.
	Movie	For viewing film-based content. Most suitable option for viewing in a theatre-like environment.
	Sports	Provides the best picture quality for viewing sports-based content.
	User	Stores your individual picture settings.
Brightness	Brightens or darkens the picture.	
Contrast	Increases or decreases picture contrast.	
Colour	Increases or decreases colour intensity.	
Sharpness	Sharpens or softens the picture.	
Advanced Picture Settings	Adjusts the advanced picture settings.	
	Colour Temperature	Adjusts the whiteness of the picture.
	Cool	Gives the white colours a blue tint.
	Warm	Gives the white colours a red tint.
	Normal	Gives the white colours a neutral tint.

DNR	Reduces the picture noise (snowy picture).	
	Low / Medium / High	Modifies the effect of the noise reduction.
	Off	Turns off the Noise Reduction feature.
Mpeg NR	Reduces the picture noise in MPEG-compressed video. This feature is activated while watching a DVD or a digital broadcast.	
	Low / Medium / High	Modifies the effect of the MPEG noise reduction.
	Off	Turns off the MPEG Noise Reduction feature.
Vibrant Colour	Makes colours more vivid.	
	Low / Medium / High	Modifies the effect of the vibrant colour.
	Off	Turns off the vibrant colour feature.
Perfect Clear	Adjusts black level of the picture automatically to suit the current scene.	
	Low / Medium / High	Modifies the effect of the perfect clear.
	Off	Turns off the perfect clear feature.
Dynamic Contrast	Sends a brighter or darker image to the screen according to the brightness level of the picture and creates a wider effect in terms of contrast.	
	Low / Medium / High	Modifies the effect of the dynamic contrast.
	Off	Turns off the dynamic contrast feature.
Dynamic Backlight	Adjust the backlight strength automatically according to the average brightness of the picture.	
	AUTO / Day / Night	Modifies the effect of the dynamic backlight.
	Off	Turns off the dynamic backlight feature.
Backlight	Adjusts the strength of the light reflected to the LCD panel.	
	 <ul style="list-style-type: none"> • If one of the “Auto”, “Day” or “Night” options is selected for “Dynamic Backlight”, the Backlight feature is grayed out and can not be accesses. 	



Sound

Volume	Press \leftarrow/\rightarrow to adjust the volume.
Balance	Adjusts the sound balance between right and left speakers.
Auto Volume	Volume levels of the broadcasters are different from each other. This may result in volume differences between channels. If this feature is set as "On", volume level is maintained when you change the channels.
Sound Type	Adjusts the sound of the speakers for a stereo or bilingual broadcast.
	Stereo For stereo broadcasts.
	Dual I / II For bilingual broadcasts, select "Dual I" for sound channel 1, "Dual II" for sound channel 2.
Surround	Gives depth to the sound of the programme you are watching.
Sound Mode	Adjusts the sound effect depending on the features of the programme you are watching.
	Music Creates sound effects that make you feel like in a concert hall.
	Clear Voice Creates effects that emphasize the conversation sounds.
	Flat Enhances clarity, detail, and sound presence.
Headphone	Adjusts the sound of a headphone connected to the TV.
Audio Description	Provides audio description (narration) of visual information if the terrestrial digital broadcast contains audio description feature.  <ul style="list-style-type: none">• "Audio Description" option is only active in digital broadcasts.



Channel Setup

Auto Tuning

Tunes in all available channels.
 You can retune the TV after moving house, or to search for new channels that have been launched by broadcasters.
 Follow the instructions on the screen to tune your TV.

Digital Manual Tuning

Tunes and stores the digital channels manually.

- 1 Press number buttons or \leftarrow/\rightarrow to select the channel number that you want to tune.
- 2 When the TV finds available channels, channel names are displayed on the lower part of the menu and channels are stored.
- 3 Press MENU to finish setting up.
 Repeat the above procedure to tune other channels.

Analogue Manual Tuning

Tunes and stores the analogue channels manually.

System / Current Channel / Search / Programme number

- 1 Press \uparrow/\downarrow to select "Programme no", then press \leftarrow/\rightarrow or number buttons to select the programme number to which the tuned channel will be stored.
- 2 Press \uparrow/\downarrow to select "System", then press \leftarrow/\rightarrow to make your selection.
BG: For Western Europe countries/regions
I: For England
DK: For Eastern Europe countries/regions
L: For France
- 3 Press \uparrow/\downarrow to select "Channel", then press \oplus to select "S" (for cable channels) or "C" (for terrestrial channels).
- 4 Tune the channels as follows:
If you do not know the channel number (frequency)
 Press \uparrow/\downarrow to select "Search", then press \leftarrow/\rightarrow . Search will start. When a channel has been found, the search will stop.
 Press \leftarrow/\rightarrow to continue searching.
If you know the channel number (frequency)
 Press \uparrow/\downarrow to select "Channel", then press the number buttons to enter the channel number of the broadcast you want to tune.
- 5 Press \uparrow/\downarrow to select "Confirm", then press \oplus .
 Changes are stored.
 Repeat the above procedure to tune other channels manually.

Fine Tuning

Allows you to fine-tune the selected channel manually if you feel that a slight tuning adjustment will improve the picture quality.
 You can fine tune between -32 and +32.

Skip	Skips unused analogue channels when you press PROG +/- to select channels. To select a channel that is set to be skipped, press the number buttons to enter the corresponding channel number.
Confirm	Saves your changes made in the Analogue Manual Tuning menu.

Programme Table You can sort the channels tuned in TV according to your personal preferences, delete channels, lock any channel you want or rename the analogue channels.

Service Type	<p>Press blue button repeatedly to select the service type. The service type you selected appears in the menu.</p> <p>ALL TYPE: Displays all channels.</p> <p>DTV: Displays digital channels only.</p> <p>ATV: Displays analogue channels only.</p> <p>RADIO: Displays radio channels only.</p> <p>DATA: Displays data channels only.</p> <p>Programme Table menu displays only the channels that are in convenience with the selected service type.</p>
Move	<p>Changes the position of a stored channel.</p> <ol style="list-style-type: none"> 1 Press \uparrow/\downarrow to select the channel you want to move. 2 Press green button. 3 Press the number buttons to enter the new position, then press \oplus. Channel will be moved to its new position. 4 Press RETURN $\star\leftarrow$ to finish setting up.
Delete	<p>Deletes a stored channel.</p> <ol style="list-style-type: none"> 1 Press \uparrow/\downarrow to select the channel you want to delete. 2 Press yellow button. 3 Press green to delete the selected channel. 4 Press red to delete the entire channel list. 5 Press RETURN $\star\leftarrow$ to finish setting up.
Name	<p>Assigns a name to the desired analogue channel, that consists of maximum 8 letters or numbers.</p> <ol style="list-style-type: none"> 1 Press \uparrow/\downarrow to select the analogue channel you want to give a name. 2 Press red button. 3 First letter will be highlighted in a square. Press \uparrow/\downarrow to select the desired letter, number or character. 4 Press \leftarrow/\rightarrow to move to the previous/next letter. Repeat the above procedure to assign a name to the other analogue channels. 5 Press (+) and then press RETURN $\star\leftarrow$ to finish setting up.

Skip	<p>Skips unused digital channels when you press PROG +/- to select channels. To select a channel that is set to be skipped, press the number buttons to enter the corresponding channel number.</p> <ol style="list-style-type: none"> 1 Press \uparrow/\downarrow to select the channel you want to skip. 2 Press \leftarrow/\rightarrow to select \ominus, then press \oplus. 3 \ominus symbol will appear next to the name of the channel to be skipped.
-------------	--

Signal Information	Provides information about Channel, Network, Modulation, signal quality and signal strength (in digital mode only).
CA - Module	Allows you to perform the settings for the CA - Module that you can insert to your TV. When a CI-module is inserted for a channel that makes scrambled broadcast in CI standards, this feature opens a submenu and allows you perform the information updates about the module.



PC Setup (for PC input)

Auto Adjust	The most suitable geometric settings in accordance with the entry mode are configured by this function.
Horizontal Position	Moves the screen to the left or to the right.
Vertical Position	Moves the screen up or down.
Size	This is the pixel clock frequency. You can narrow down or enlarge the display by selecting a desired value
Phase	Using \leftarrow/\rightarrow , you can ensure that the colours and shapes are exactly consolidated on the PC image.
Auto Adjust Mode	Automatically adjusts the display position, and phase of the picture in PC mode.



Timer



Clock	Allows you to set the clock manually. When the TV receives digital channel broadcasts, you cannot set the clock manually since the time code is obtained automatically from the broadcast signal.
Off Time	TV switches to the standby mode automatically at the specified times and dates.
Repeat / Hour / Minute	<ol style="list-style-type: none"> 1 Press \uparrow/\downarrow to select "Repeat", then press \leftarrow/\rightarrow to select the repeating interval. 2 Press \uparrow/\downarrow to select "Hour", then press \leftarrow/\rightarrow to enter the hour value. 3 Press \uparrow/\downarrow to select "Minute", then press \leftarrow/\rightarrow to enter the minute value. 4 Press RETURN \leftarrow to finish setting up.

On Time	TV turns on from the standby mode automatically at the specified times and dates.
Activate / Hour / Minute / Volume / Mode / Programme	<ol style="list-style-type: none"> 1 Press \uparrow/\downarrow to select "Activate", then press \leftarrow/\rightarrow to select the repeating interval. 2 Press \uparrow/\downarrow to select "Hour", then press \leftarrow/\rightarrow to enter the hour value. 3 Press \uparrow/\downarrow to select "Minute", then press \leftarrow/\rightarrow to enter the minute value. 4 Press \uparrow/\downarrow to select "Volume", then press \leftarrow/\rightarrow to select the volume at which you want your TV to turn on. 5 Press \uparrow/\downarrow to select "Mode", then press \leftarrow/\rightarrow to select the mode at which you want your TV to turn on. 6 If the mode is set to DTV, ATV or Radio, then press \leftarrow/\rightarrow to select the programme number at which you want your TV to turn on under the "Programme" option. 7 Press RETURN $\star\leftarrow$ to finish setting up.
Sleep Timer	Allows the TV to switch itself into the standby mode automatically after the specified time, which can be set between 10 and 240 minutes, has elapsed.
Auto Sleep	When this function is set to "On", TV will switch itself into Standby mode after 5 minutes if it does not receive any signal from any of the sources.
Time Zone	Allows you to manually select the time zone you are in, if it is not the same as the default time zone setting for your country/region.



Options

Language Settings	Allows you to make all language settings.
Language Settings	Selects the language in which the menus are displayed.
Audio Languages	Selects the language used for a programme. Some digital channels may broadcast several audio languages for a programme.
Subtitle Languages	Allows you to select the subtitle language.
Hard of Hearing	When "Hard of Hearing" is selected, visual aids will be displayed together with the subtitles (if broadcaster supports visual aids).
Restore Factory Defaults	<p>Returns all settings to factory settings and the Installation Guide is displayed.</p> <p></p> <ul style="list-style-type: none"> • Do not turn off the TV, unplug it or press any button while restoring the factory settings (approximately 30 seconds). • Favourite lists, country/region, language and all settings about the auto-tuned channels will be reset to the factory settings.
Country	"Country" option is grayed out and can not be modified. The country that was selected during the initial start-up will automatically be displayed in the menu.

Game Mode	<p>Game Mode is only active for PC, HDMI, YPBPR sources. When the Game Mode is set to "On" for these sources, picture mode in picture menu will automatically be switched to the Game mode. You can only modify the colour temperature and backlight settings in this mode. Game mode provides a considerable enhancement in picture quality for game consoles, and for displaying the text files when the TV is used as a monitor. We recommend you to turn this mode "Off" when you want to watch a movie from one of the above mentioned sources.</p>		
Automatic Update	<p>Allows the TV to receive the software updates automatically (when they are broadcast) through your current aerial/cable connection. It is suggested you to keep this setting always "On".</p>		
	<p> <ul style="list-style-type: none"> • Automatic Update option does not appear in the menu in Analogue mode. </p>		
RF Software update	<p>Allows your TV receive software updates (when they are broadcast) through manual software scan if the Software Update function is "Off".</p>		
USB Software update	<p>Allows to make software update through USB input.</p>		
HDMI Set-up	<p>This function allows the TV to communicate with equipment connected to HDMI socket, through Control for HDMI.</p>		
	<p> <ul style="list-style-type: none"> • This menu appears under "Preference" menu when the input source is set to HDMI. </p>		
	<table border="0"> <tr> <td data-bbox="352 726 554 750">Control for HDMI</td> <td data-bbox="599 726 1019 821">HDMI allows to set the TV so that it will communicate with an HDMI-control compatible equipment. When it is set as "On", following menu operations can be performed.</td> </tr> </table>	Control for HDMI	HDMI allows to set the TV so that it will communicate with an HDMI-control compatible equipment. When it is set as "On", following menu operations can be performed.
Control for HDMI	HDMI allows to set the TV so that it will communicate with an HDMI-control compatible equipment. When it is set as "On", following menu operations can be performed.		
	<table border="0"> <tr> <td data-bbox="352 837 532 861">Auto Device Off</td> <td data-bbox="599 837 1024 909">When this function is set to "On", HDMI-control compatible equipment turns off as well when the TV is turned off.</td> </tr> </table>	Auto Device Off	When this function is set to "On", HDMI-control compatible equipment turns off as well when the TV is turned off.
Auto Device Off	When this function is set to "On", HDMI-control compatible equipment turns off as well when the TV is turned off.		
	<table border="0"> <tr> <td data-bbox="352 925 476 949">Auto TV on</td> <td data-bbox="599 925 980 997">When this function is set to "On", the TV is turned on as well when the HDMI-control compatible equipment is turned on.</td> </tr> </table>	Auto TV on	When this function is set to "On", the TV is turned on as well when the HDMI-control compatible equipment is turned on.
Auto TV on	When this function is set to "On", the TV is turned on as well when the HDMI-control compatible equipment is turned on.		
	<table border="0"> <tr> <td data-bbox="352 1013 565 1037">Device List Update</td> <td data-bbox="599 1013 1024 1189">Creates or updates the "HDMI Device List". Maximum 11 HDMI-control compatible equipment can be connected together. Maximum 5 equipment can be connected to a single socket. You can update the "HDMI Device List" as well when you change the connections or settings of the HDMI-control compatible equipment.</td> </tr> </table>	Device List Update	Creates or updates the "HDMI Device List". Maximum 11 HDMI-control compatible equipment can be connected together. Maximum 5 equipment can be connected to a single socket. You can update the "HDMI Device List" as well when you change the connections or settings of the HDMI-control compatible equipment.
Device List Update	Creates or updates the "HDMI Device List". Maximum 11 HDMI-control compatible equipment can be connected together. Maximum 5 equipment can be connected to a single socket. You can update the "HDMI Device List" as well when you change the connections or settings of the HDMI-control compatible equipment.		
	<table border="0"> <tr> <td data-bbox="352 1204 554 1228">HDMI Device List</td> <td data-bbox="599 1204 1036 1252">Displays the HDMI-control compatible equipment that are connected.</td> </tr> </table>	HDMI Device List	Displays the HDMI-control compatible equipment that are connected.
HDMI Device List	Displays the HDMI-control compatible equipment that are connected.		
Decoder Settings (for AV1)	<p>Allows you to view and record the scrambled channel when using a decoder connected directly to scart connector AV1 via a recorder.</p>		



Parental Control

Lock System

When this function is set to "On", a password will be prompted when a user wants to enter the Auto tuning, Digital Manual Tuning, Analogue Manual Tuning and Programme Table menus under the Channel Setup menu.



- The password of the Parental Control menu is assigned as "9999" at the factory. You can change it as desired.

Set PIN

- 1 Press ⊕.
- 2 Press the number buttons to enter the new PIN code.
- 3 Press the number buttons to enter the PIN code that was entered in step 2.



- In case you forget the PIN code, 9999 is always accepted.

Block Programme

Allows you to prevent watching the desired programmes. Enter the correct PIN code to watch the blocked programmes.

- 1 Press ⊕.
- 2 Press $\hat{\wedge}/\hat{v}$ to select the channel you want to block.
- 3 Press green button.
Repeat the above procedure to block other channels.
- 4 Press RETURN \blacktriangleleft to finish setting up.

Parental Guidance

Sets an age restriction for programmes. To watch a programme rated above the age you have specified, enter the correct PIN code.

- 1 Press \hat{r}/\hat{t} to select the age restriction or "Off" (for unrestricted watching).
- 2 Press RETURN \blacktriangleleft to finish setting up.

Panel Lock

If you set the Panel Lock to "On", control buttons on the TV will be locked and become non-functional.

Additional Information

Installing the Accessories (Wall-Mount Bracket)

To Customers:

For product protection and safety reasons, Sony strongly recommends that installing of your TV be performed by licensed contractors. Do not attempt to install it yourself.

To Sony Dealers and Contractors:

Provide full attention to safety during the installation, periodic maintenance and examination of this product.

Your TV can be installed using a Wall-mount bracket VESA compliant with 75x75mm fixings
Wall mount bracket is not supplied with TV set.

Steps:

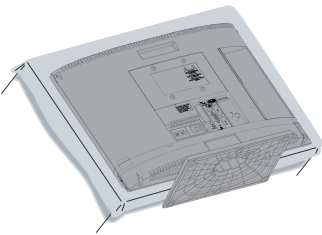

- 1 Place on the Table as shown below, protection screen with Protection bag, when securing the Wall Mount

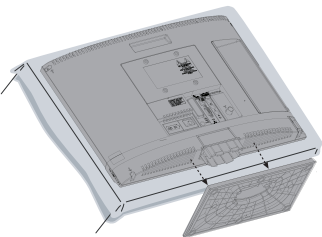



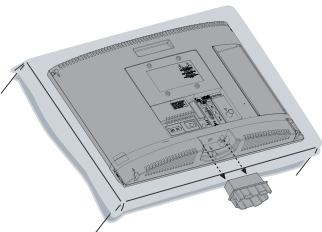









- 2 Detach Stand from TV set (refer page 6)



- 3 Unscrew and Disassemble Neck from TV set

- 4 Refer to the Instructions supplied with the Wall Mount Bracket (not supplied with TV set).

Specifications

Model name	KDL-19BX200	KDL-22BX200
System		
Panel System	LCD (Liquid Crystal Display) Panel	
TV System	Analogue: Depending on your country/region selection: B/G, D/K, I, L Digital: DVB-T	
Colour/Video System	Analogue: PAL, PAL60 (only video input), SECAM, NTSC3.58, NTSC4.43 (only video input) Digital: MPEG-2 MP@ML/HL, H.264/MPEG-4 AVC MP/HP@L4	
Channel Coverage	Analogue: VHF:E2-12 / UHF: E21-E69 / CATV:S1-S20 / HYPER: S21-S41 / D/K: R1-R12, R21-R69 / L: F2-F10,B-Q, F21-F69 / I: UHF B21-B69 Digital: VHF / UHF	
Sound Output	3 + 3 W	
Input/Output jacks		
Aerial / Cable	75 ohm external terminal for VHF / UHF	
 /  /  AV1	21-pin scart connector including audio / video input, S-Video input, RGB input and TV audio/video output.	
 / Y Pb Pr IN	Supported formats: 1080p, 1080i, 720p, 576p, 576i, 480p, 480i Y: 1 Vp-p, 75 ohm, 0.3V negative sync. / Pb/Cb: 0.7 Vp-p, 75 ohm / Pr/Cr: 0.7 Vp-p, 75 ohm	
 Y Pb Pr IN	Audio input (mini jack)	
HDMI IN	Supported formats: 1080/24p, 1080p, 1080i, 720p, 576p, 576i, 480p, 480i Audio: Two channel linear PCM: 32, 44.1 and 48 kHz, 16, 20 and 24 bit, Dolby Digital 32, 44,1 and 48 kHz, Max bit rate 640 kHz PC input (see page 32)	
 PC	PC input (D-sub 15-pin) (see page 32) G: 0.7 Vp-p, 75 ohm, non Sync on Green/B: 0.7 Vp-p, 75 ohm / R: 0.7 Vp-p, 75 ohm	
 PC	Audio input (mini jack)	
 AV2	Video input (phono jack)	
 AV2	Audio input (phono jacks)	
	Headphones jack input	
	USB input	
	CAM (Conditional Access Module) input	
Power and others		
Power Requirements	220-240V AC, 50 Hz	
Screen Size (measured diagonally)	19 inches / Approx. 47 cm	22 inches / Approx. 55 cm
Display Resolution	1,366 dots (horizontal) x 768 lines (vertical)	
Power Consumption	27.0 W	43.0 W

Standby Power Consumption		0.76 W	
Average annual energy Consumption *1		39 kWh	63 kWh
Dimensions (W x H x D) (Approx)	(with stand)	457.3 x 334.5 x 152.6 mm	524.5 x 375.2 x 152.6 mm
	(without stand)	457.3 x 310.8 x 62.8 mm	524.5 x 352.3 x 66.7 mm
Mass (Approx.)	(with stand)	4.5 Kg	5.1 Kg
	(without stand)	3.9 Kg	4.5 Kg
Supplied Accessories		Refer to “Checking the accessories” (page 4)	

Design and specifications are subject to change without notice.

*1 4 hours a day and 365 days a year.

PC Input Signal Reference Chart for PC and HDMI IN

Resolution			Horizontal frequency (kHz)	Vertical frequency (Hz)	Standard
Signals	Horizontal Pixel	Vertical (Line)			
VGA	640	480	31.5	60	VESA
	640	480	37.5	75	VESA
	720	400	31.5	70	VESA
SVGA	800	600	37.9	60	VESA
	800	600	46.9	75	VESA
XGA	1024	768	48.4	60	VESA
	1024	768	56.5	70	VESA
	1024	768	60.0	75	VESA
WXGA	1280	768	47.8	60	VESA
	1280	768	47.4	60	VESA
	1360	768	47.7	60	VESA





- For the best picture quality, it is recommended to use the signals in the above chart with a 60 Hz vertical frequency (boldfaced).

Troubleshooting

Picture

No picture (screen is dark) and no sound

- Check the aerial/cable connections.
- Connect the TV to the mains, and press  on the side of the TV.
- If the (standby) indicator lights up in red, press .

No picture or no menu information from equipment connected to the scart connector

- Press  to display the connected equipment list, then select the desired input.
- Check the connection between the optional equipment and the TV.

Double images or ghosting

- Check the aerial/cable connections.
- Check the aerial location and direction.

Only snow and noise appear on the screen

- Check if the aerial is broken or bent.
- Check if the aerial has reached the end of its service life (three to five years in normal use, one to two years at the seaside).

Picture or sound noise when viewing a TV channel

- Perform fine tuning to obtain better picture reception (page 24).

Some tiny black points and/or bright points appear on the screen

- The picture of a display unit is composed of pixels. Tiny black points and/or bright points (pixels) on the screen do not indicate a malfunction.

No colour on programmes



- Select “Restore Factory Settings” (page 27).

No colour or irregular colour when viewing a signal from the Y Pb Pr (Component) sockets

- Check the connection of the Y Pb Pr (Component) sockets and check if each socket is firmly seated in their respective sockets.

Sound

No sound, but good picture

- Press  + or  (Mute).

Channels

The desired channel cannot be selected

- Switch between digital and analogue mode and select the desired digital/analogue channel.

Some channels are blank

- Scrambled/Subscription only channel. Subscribe to the pay TV service.
 - Channel is used only for data (no picture or sound).
 - Contact the broadcaster for transmission details.
- ### Digital channels are not displayed
- Contact a local installer to find out if digital transmissions are provided in your area.
 - Upgrade to a higher gain aerial.

General

The TV turns off automatically (the TV enters standby mode)

- Check if the “Off Time” (page 26) or “Sleep Timer” (page 27) is activated.
- If no signal is received and no operation is performed in the TV mode for 5 minutes, the TV automatically switches to standby mode.

Distorted picture and/or sound

- Keep the TV away from electrical noise sources such as cars, motorcycles, hair-dryers or optical equipment.
- When installing optional equipment, leave some space between the optional equipment and the TV.
- Check the aerial/cable connections.
- Keep the aerial/cable TV cable away from other connecting cables.

The remote does not function

- Replace the batteries.

Keep this important information about how to re-tune your TV during the digital TV switchover

Keep this information safe
— you'll need it

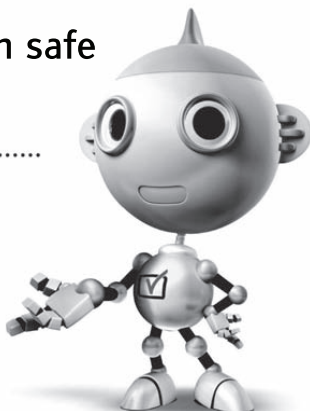

Television in the UK is going digital, bringing us all more choice and new services. Starting in late 2007 and ending in 2012, television services in the UK will go completely digital, TV region by TV region. Please see overleaf to find out when your area switches to digital.

Digital UK is the independent, non-profit organisation leading the process of digital TV switchover in the UK. Digital UK provides impartial information on what people need to do to prepare for the move to digital, and when they need to do it.

How the switchover affects your TV equipment:

Your new TV has a digital tuner built in, which means it is ready to receive the Freeview signal by simply plugging it into your aerial socket (check if you can get digital TV through your aerial now, or whether you'll have to wait until switchover, at www.digitaluk.co.uk).

When the TV switchover happens in your area, there are at least two occasions when you will need to re-tune your TV in order to continue receiving your existing TV channels, and also to pick up new ones. Digital UK, the body leading the digital TV switchover, will advise you when you need to re-tune during the switchover. If you choose to connect your TV to satellite or cable with a digital box then it will not be affected by switchover, and you won't need to re-tune.

How to re-tune

- 1 Press "MENU on the remote.
- 2 Press \uparrow/\downarrow select "Settings then press \oplus .
- 3 Press \uparrow/\downarrow select "Channel Setup" then press \oplus .
- 4 Press \uparrow/\downarrow select "Auto Tuning" then press \oplus .
- 5 Press \uparrow/\downarrow select "Scan Type" and press \leftarrow/\rightarrow select "DTV" then press \oplus .
- 6 Follow the on screen instructions.

If you are missing any channels, it may be that they are not available in your area, or that your aerial needs upgrading.

If you have any questions, please contact

Sony on **08705 111 999** or call Digital UK on **0845 6 50 50 50** or visit **www.digitaluk.co.uk**

When does switchover happen?

*Copeland switches on October 17, 2007



The map shows the following switchover dates by region:

- STV North: 2010
- STV Central: 2010/11
- Ulster: 2012
- Border: 2008/09
- Tyne Tees: 2012
- Yorkshire: 2011
- Granada: 2009
- Wales: 2009/10
- Central: 2011
- Anglia: 2011
- London: 2012
- West: 2010
- Meridian: 2012
- West Country: 2009

Inset map: Shetland Islands

The exact date you switch depends on the transmitter you are served by. To check when you switch, go to Digital UK's postcode checker on www.digitaluk.co.uk

Check your ITV news service or look at Teletext page 106 to see what TV region you're in.

Visit us at digitaluk.co.uk call us on **0845 6 50 50 50***

*Calls charged at BT rate of 3p per minute daytime and 1p per minute evenings and weekends. Rates may vary for calls from non-BT lines.



Useful information for Sony products.

<http://www.sony-europe.com/myproduct/>

<http://www.sony.net/>

© 2010 Sony Corporation



4193041

4-193-041-12

HRE.801G-01